



*Approved for Digital
Weigh Indicator*

Digital Weighing Indicator

Instruction Manual

Model : DN500N

DACELL CO.,LTD

TEL : +82-43-260-2242

FAX : +82-43-260-2242

WEBSITE: <http://www.dacell.com>

EMAIL : info@dacell.com

CONTENTS

1. Before Installation	-----	2 Page
2. Introduction	-----	3 Page
3. Specification	-----	4 Page
4. Installation	-----	10 Page
5. Set-Up	-----	12 Page
6. Interface	-----	33 Page
7. Error and Treatment	-----	48 Page

1. BEFORE INSTALLATION

1-1. Caution / Warning Marks



This mark warns the possibility to arrive death or serious injury in case of wrongly used.



This mark cautions the possibility to arrive serious human body injury or product lose in case of wrongly used.

1-2. Other Marks



Warning for Electric Shock or Damage.
Please do not touch by hand



Protective Ground(Earth) terminal



Prohibition of Operation process

1-3. Copy Rights

- 1). All Right and Authority for this Manual is belonged to DACELL CO.,LTD.
- 2). Any kinds of copy or distribution without DACELL CO.,LTD..'s permission will be prohibited.

1-4. Inquiries

If you have any kinds of inquiries for this model, please contact with your local agent or Head Office.

Head Office : DACELL co.,Ltd.

Website : <http://www.dacell.com>

Email : info@dacell.com

2. INTRODUCTION

2-1. Introduction

Thank you for your choice, this “DN500N” Industrial Digital Weighing Indicator..

This “DN500N” model is simple application usage Digital Weighing Indicator, with powerful communication performance.

With 2ports serial port communication and High Speed A/D conversion performance will lead you to precise weighing process.

This “DN500N” Weighing Indicator is simple application model, and it can be used for “Truck Scale, Platform Scale, Tank Scale.

Please review this instruction Manual and learn more about information about “DN500N”.

Enjoy your process efficiency with “DN500N” Weighing Indicator..

2-2. Cautions



- 1). Don't drop on the ground or avoid serious external damage on item.
- 2). Don't install under sunshine or heavy vibrated condition.
- 3). Don't install place where high voltage or heavy electric noise condition.
- 4). When you connect with other devices, please turn off the power of item.
- 5). Avoid from water damage.
- 6). For the improvement of function or performance, we can change item specification without prior notice or permission.
- 7). Item's performance will be up-dated continuously base on previous version's performance.

2-3. Features

- 1). All Modules and Option Cards are isolated to maximize accuracy and performance.
- 2). External input terminal inside.
- 3). By using “Photo-Coupler” on each module(Option, Analog board, In/Out), we improved “Impedance problem”, “Isolation ability among inputs”, “Leading power problem”, and “Noise covering function”.
- 4). Data back-up function, when the sudden power off
- 5). Polycarbonate film panel, strong against dust and water
- 6). RS-232C (Com. Port1) is standard installed.
- 8). Variable options(Order in advance)

2-4. Box Contents

- 1). Power Cable(1pcs) / Load cell Connector(1pcs) / Manual(1pcs)

3. SPECIFICATION

3-1. Analog Input & A/D Conversion

Input Sensitivity	0.2 μ V / Digit
Load Cell Excitation	DC 10V (- 5V ~ + 5V)
Max. Signal Input Voltage	Max.32mV
Temperature Coefficient	[Zero] \pm 20PPM/ $^{\circ}$ C [Span] \pm 20PPM/ $^{\circ}$ C
Input Noise	\pm 0.6 μ V P.P
Input Impedance	Over 10M Ω
A/D Conversion Method	Sigma-Delta
A/D Resolution(Internal)	520,000 Count(19bit)
A/D Sampling Rate	Max. 200times / Sec
Non-Linearity	0.01% FS
Display Resolution(External)	1/30,000

3-2. Digital Part

Display	Parts	Specification
Display	Main Display	7Segments, 6digits Red color FND Size : 20.0(H) x13.0(W)mm
	Min. Division	x1, x2, x5, x10, x20, x50
	Max. display value	+999,950
	Under Zero value	"-" (Minus display)
Status lamp	Steady, Zero, Tare, Gross, Auto, Print, Hold, RTxD	Green color Condition display Lamp (8pcs)
Key	Number, Function Key	Number Key, Function (16pcs)

3-3. General Specification

Power Supply	SMPS Free Voltage Power Supply(AC85~265V)
Operating Temperature Range	-5℃ ~ 40℃
Operating Humidity Range	Under 85% Rh (non-condensing)
External Dimension	193mm(W) x 100mm(H) x 140mm(L)
Net Weight(kg)	About 1.5kg
Gross Weight(kg)	About 2.0kg

3-4. Option Card

Option No.1	Analogue Output (0~10V)
Option No.2	Analogue Output (4~20mA)
Option No.3	Serial Interface : RS422 / RS485
Option No.4	BCD Input
Option No.5	BCD Output

※ Serial Interface (RS-232C) or Current Loop is Standard installed.

3-5. Front Panel (Display & Key pad)













3-5-1. Status Lamp (ANNUNCIATORS) : Green Color Lamp is "ON".

Steady	When the weight is Steady, "▼" Lamp is turn on.
Zero	When the current weight is Zero, "▼" Lamp is turn on. (Displayed weight is Zero, "▼" Lamp is turn on.)
Tare	Tare function is set, "▼" Lamp is turn on. (Tare Reset → "▼" Lamp is turn off.)
Gross	When "Gross Weight display mode", Lamp is "ON" (Under "TARE" Setting mode, only)
Auto	When "Automatic Print Mode" setting, Lamp is "ON"
Print	When "Print" key input, Lamp is "ON".
Hold	When "Hold" function is set, Lamp is "On"
RTxd	When indicator transfers or receives data from other devices, Lamp is turn on. (If the Lamp is off although there is some data transference, please check communication settings).

3-5-2. Key Pad Function

ZERO	Make Weight value as Zero. Under F08, you can set the Zero key operation range, as 2%, 5%, 10%, 20% or 100% of Max. Capacity. ※ Under "Tare" key input, Zero key will not be activate within operation range.
TARE	Make Weight value as Zero, including Tare Weight. Under F09, you can set the Tare key operation range, as 10%, 20%, 50%, or 100% of Max. Capacity. ※ Whenever pressing "Tare" key, you can set the Tare continuously.
TARE PESET	TARE RESET 1. Remove the Set TARE function. - If you press this key, TARE set value will be removed and display gross weight.
GROSS NET	Under "TARE" setting, you can select weight display mode. First input, Gross Weight will be displayed, second input, Net weight will be displayed. ※ This key will be activated only under "TARE" set.
1 HOLD	Hold the Weight display when indicator detects "Peak Hold", "Sample Hold" or "Average Hold".
2 RESET	Release set "HOLD" function.

	<p>To Set "Auto Print" mode. Under Auto Print Mode, When the weight will be increased over than "Empty Range" and steady, steady weight will be printed automatically. ※ Under "Auto Print" mode, Steady weight will be printed and Save on Sub-Total and Grand-Total Data.</p>
	<p>Under Print installation, you can print out the "Sub-total data" of current P/N. Printed Data : Accumulated count and weight of current P/N.</p>
	<p>Under Print installation, you can print out the "Grand-total data" of current P/N. Printed Data : Accumulated count and weight of All P/N.</p>
	<p>Manual Print Whenever press this key, you can print out.</p>
	<p>You can set each weighing process as a certain P/N. And you can call certain P/N with pressing this key. P/N save : Select P/N and Enter key input. P/N call : P/N + Number key + Enter</p>
	<p>Under each "Part No.(P/N)", you can make more detailed sorting function with this key. Under each P/N, you can set Max. 6digit code, and manage the each code. Code Check : Code key input, them Code No. will be displayed during 3sec. Code Change : Code key input, then enter new Code value with No. key and Enter to save.</p>
	<p>Check Accumulated Weighing Count from beginning. Max. Serial No. Display : Max. 99,999 If the Serial No. is beyond 99,999, count will be return to 00,000. But, indicator will take all serial count, even if the display will be 00,000. S/N Check " S/N key input, then Accumulated serial No. will be displayed during 3sec. S/N Change : S/N key input, then press new S/N count and press Enter to save.</p>
	<p>. Calibration mode - Digit setting Whenever pressing "0"key, digit will be change 1, 2, 5, 10, and 50.</p>
	<ol style="list-style-type: none"> 1. Modify the set value during setting process. 2. Calibration mode - Move back to previous step. 3. F-function setting mode - Change F-function No. F-function no.(number key) + Clear → directly move
	<ol style="list-style-type: none"> 1. Save set value during setting process. 2. Calibration mode - Save current setting and move to next step. 3. F-Function mode - Save current F-function setting, and move to next F-function



※ Function Keys (Combined Key functions : CLEAR key + other keys)

		Time set value check or Change
		Date set value check or Change
		Sub-total Date Delete
		Grand-total Data Delete
		Key Tare function activated. (To Reset the key tare, press Tare Reset key.)

3-6. Rear Panel

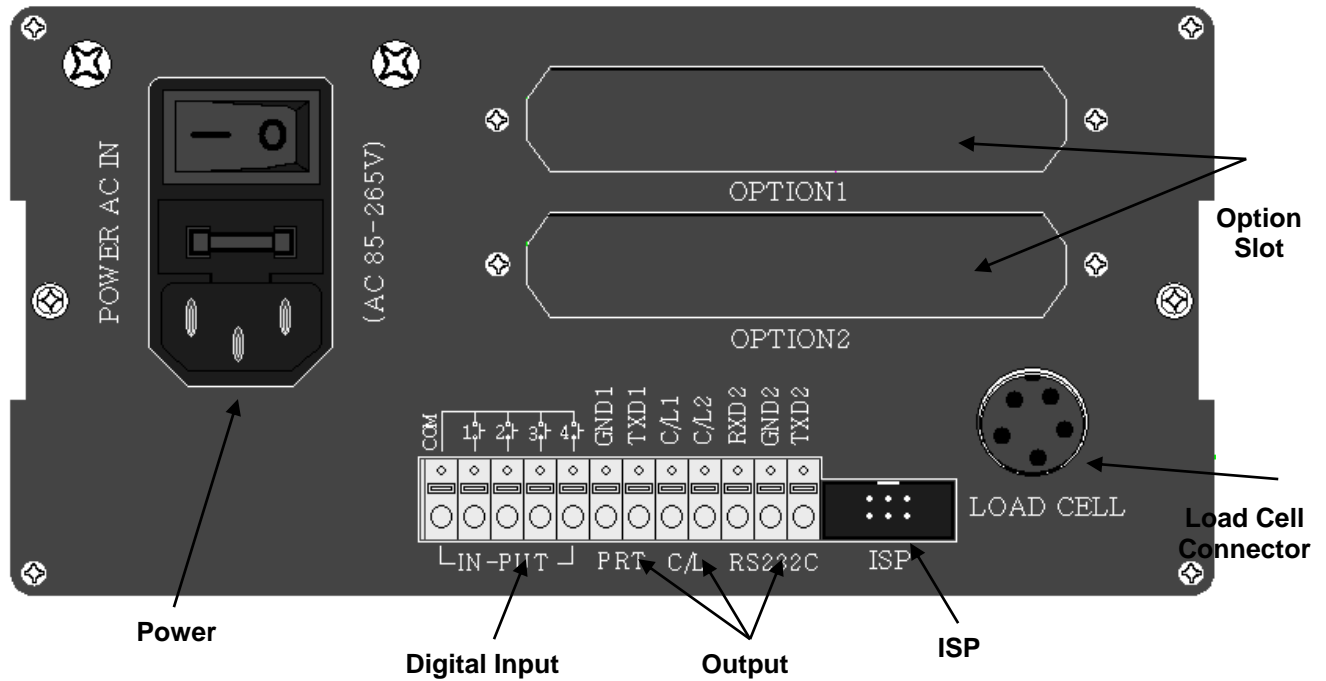

①POWER	-Power ON/OFF Switch -Fuse : AC 250V 10A -AC IN : AC86~265V Power In
②OPTION 1,2	- OPTION BOARD install slot. - ANALOG out, Serial I/F, etc
③LOAD CELL CONNECTOR (N-16)	-EXC + (+5V) PIN1 (RED) -EXC - (-5V) PIN2 (WHITE) -SIG+ PIN3 (BLUE or Black) -SIG- PIN4 (GREEN) -SHIELD PIN5 (SHEILD)
④Digital Input	- Digital Input Signal terminal Refer to "F-function 11".
⑤Output Terminal	-RS-232C/CURRENTLOOP (Standard Installed) (GND,TXD1,CL1,CL2,RXD,GND,TXD)
⑥ISP (Digital Lock Pin)	- Insert "Lock Pin Header", to protect "F-function" data and other settings from Electric Noise effect. - To change the setting, please remove the "Lock Pin Header".

4. INSTALLATION

4-1. External Dimension & Cutting Size

(External Dimension) (unit : mm)

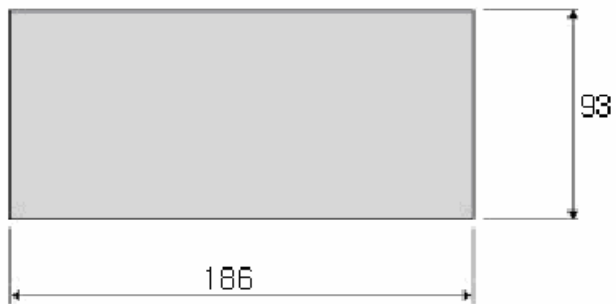
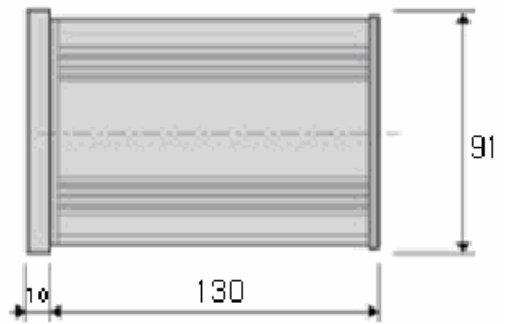
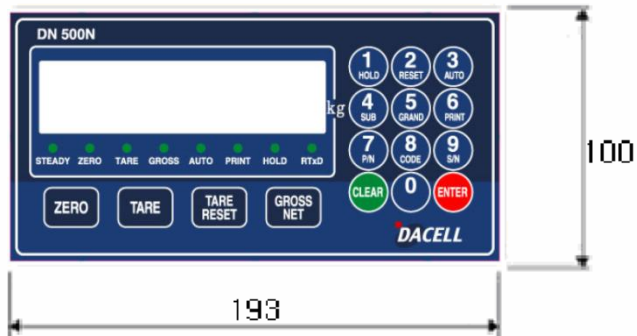
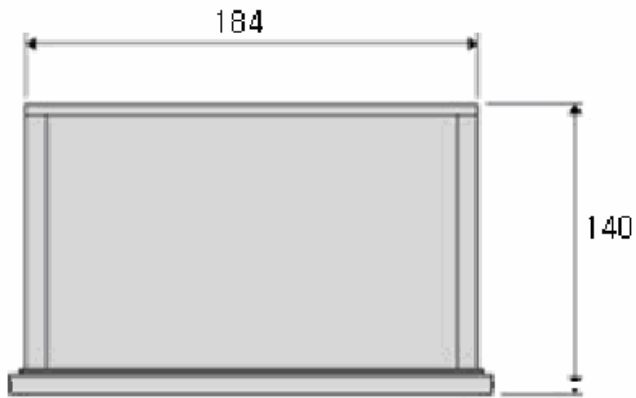

Chapter 5. Set Up

5-1. Calibration



Adjust weight balance between “Real weight” on the load cell(Weight Part) and “Displayed weight of Indicator”. When you replace LOAD CELL or Indicator, you have to do Calibration process once again



5-2. Test Weight Calibration (span Calibration) – Mode 1.

- **Applicable model : DN500N series**

Prepare at least 10% of Max. capacity of your weighing scale.



Step 1. Enter Calibration Mode

Press  key during 5 sec →  display.

Or turn on the Power + with pressing  →  display

Press  key →  display

Press  key to start “Calibration Mode”.

Remarks : Go to next step with save  key / Back to previous step  key

Step 2. Digit(Division)setting ( display)

Press  key and stop the optimal Digit value.

(Whenever pressing  key, digit value will be changed, like 01-02-05-10-20-50)

Press  key and save change and move to next step.

Step 3. Max. Capacity Setting ( →  display)

Input Max. Capacity of Scale with No. keys.

Input Capacity and press  key, and move to next step.

※ **Caution**
(Max. capacity value / division value) can not be over 30,000.(as Indicator resolution is 1/30,000).

Step 4. Zero Balance setting ( display)

Make empty the scale part, and press  key.

Indicator check the current Zero balance and save the value and move next step.

Step 5. Span value calculation ( →  → )

Input prepared Test weight value with No. keys.

And press  key.

Then, display will show  and then, load prepared test weight unit on the scale.

After a few seconds(to remove the vibration effect), press  key.

Then, indicator will calculate Span value and move the next step.

※ **Caution**
For the precise Span calibration, please prepare Test weight unit, at least 10% of Max. capacity of Scale.

Step 6. Check Span Value and Finish the Calibration( → )



Check the Calculated Span value.

And after 3sec,  will displayed automatically and move to weighing Mode.

5-3. Simulation Calibration Mode (Without Test Weight) – Mode 2.

- This calibration Method will be useful to make calibration more than 10ton capacity setting.
- Guaranteed resolution will be 1/5,000 and if you need higher resolution, please make calibration with Test weight.



Step 1. Enter to the “SET-CAL” mode

Press  key during 5 sec →  display.

Or turn on the Power + with pressing  →  display

Press  key →  display.

Press  key to start “Simulation Calibration Mode”.

Remarks : Go to next step with save  key / Back to previous step  key Step 2.

Step 2. Digit (Division)setting ( →  display)

Press  key and stop the optimal Digit value.

(Whenever pressing  key, digit value will be changed, like 01-02-05-10-20-50)

Press  key and save change and move to next step.

Step 3. Max. Capacity of Load cell ( →  display)

Input Max. Capacity of Scale with No. keys.

- Under this step, input Total sum of each load cell's Max. Capacity. (Not weighing Scale)
- The Max. Capacity of load cell is stated on “Test report” or “Label”.
- If you installed 4 load cells, and each load cell's Max. Capacity is 500kg, then you have to input 2,000kg, as a Max. Capacity.

Input Capacity and press  key, and move to next step.

Step 4. Measure/Adjustment optimal Zero balance of Scale ( display)

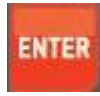

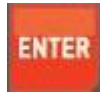
Make empty the scale part, and press  key.

Indicator check the current Zero balance and save the value and move next step.

Step 5. Input Max. Output Rate (mV/V) value of load cell

Input Max. Output Rate(mV/V) value of load cell with No. keys.

- Under this step, input Max. Output rate(mV) of load cell.
- If you installed a few pieces of load cells, the connection will be parallel, so the rated output of a few load cells are as same as single load cell's rated output.
- The Output rate is stated on "Test report" or "Label"



And press  key.

Step 6. End Calibration and Auto Reset

- Calculated Span value will be displayed and automatically reset and move the normal weight indicating mode.



5-4. Function Setting – Mode 1.

- **Applicable model : DN500N series**

To make more accuracy performance of Digital Weighing Indicator, through this Function setting.



Step 1. Enter to Function setting mode.

Turn on the Power + with pressing  →  display

Press  key →  display

Press  key to start “F-function Mode”.

Step 2. Change the F-Function No.

To change the F-function No., press  key. whenever pressing  key, Function No. will be changed

If you want to move certain function No. directly, press function No. with keypad and press  key.

Step 3. Change the Set value.

Input new set value with keypad, and press  key to save new setting.

If you don't press  key, after changing the set value, the new set value will not be saved.

Step 4. Exit from Function setting mode.

Press  +  +  key to exit function mode.

5-4. Function List

Function No.	Contents	Remark
F01	Decimal point setting	Setting range : 0~3
F02	Back up mode selection	Setting range : 0, 1
F03	Motion Band setting	Setting range : 0~9
F04	Zero Tracking setting	Setting range : 0~9
F05	Auto Zero Range setting	Setting range : 00~99
F06	Digital Filter setting	Setting range : 00~49
F07	Zero / Tare key activating setting	Setting range : 0, 1
F08	Zero key operating range setting	Setting range : 0~4
F09	Tare key operating range setting	Setting range : 0~3
F10	Hold Function setting	Setting range : 0~4
F11	Digital Input setting	Setting range : 0~7
F12	Code No. Setting	Setting range : 0~2
F13	Serial No. key setting	Setting range : 0, 1
F14	Hold Off time setting	Setting range : 0.0 ~ 9.9sec
F30	Serial I/F Parity Bit setting (Port No.1)	Setting range : 0~2
F31	Serial I/F Communication Speed setting (Port No.1)	Setting range : 0~9
F32	Serial I/F Mode setting (Port No.1)	Setting range : 0~2
F33	Serial I/F Transference Method setting (Port No.1)	Setting range : 0~5
F34	ID Number setting	Setting range : 1~99
F35	Transferred Data Format (Port No.1)	Setting range : 0~2
F36	BCC selection mode	Setting range : 0, 1
F37	Data Transference count setting (Port No.1)	Setting range : 0~6
F40	Serial I/F Parity Bit setting (Port No.2-Option)	Setting range : 0~2
F41	Serial I/F Communication Speed setting (Port No.2 – Option)	Setting range : 0~9
F42	Serial I/F Mode setting (Port No.2 - Option)	Setting range : 0~2
F43	Serial I/F Transference Method setting (Port No.2 - Option)	Setting range : 0~5
F45	Transferred Data Format (Port No.2 - Option)	Setting range : 0~2
F47	Data Transference count setting (Port No.2 - Option)	Setting range : 0~6
F50	Weight Unit Selection (Printer)	Setting range : 0~2

Function No.	Contents	Remark
F51	When Automatically print, Data output selection	Setting range : 0, 1
F52	Print format selection	Setting range : 0, 1
F53	Sub-Total Data delete Selection	Setting range : 0, 1
F54	Paper withdraw rate Selection	Setting range : 0~9
F55	Print Line interval Selection	Setting range : 0~9
F56	Sub-Total Print Mode Selection	Setting range : 0, 1
F57	Print Language Selection	Setting range : 0~3
F58	Print Delay time selection	Setting range : 0.0 ~ 9.9sec
F60	BCD output Selection	Setting range : 0, 1
F63	Average Display setting	Setting range : 0.0 ~ 9.9sec
F64	Steady LED Status Lamp Delay time setting	Setting range : 0.0 ~ 9.9sec
F65	Tension and Compression setting	Setting range : 0, 1
F80	Empty(Near Zero) Range Setting	XXXXXX
F81	Zero Range Setting	Setting range : 0~Max. Capa
F83	Analogue output setting	Under option installed
F89	Span Value check	
F90	Date check / change	
F91	Time check / change	

5-5. Function List detailed information.

Decimal Point Setting				
F01	●	0	No Decimal point	
		1	1 st place under Zero (0.0)	
		2	2 nd place under Zero (0.00)	
		3	3 rd place under Zero (0.000)	
Back up mode selection				
F02	●	0	Normal mode	
		1	Back up mode	
Motion Band Range setting				
F03	5	0 ┆ 9	This is set "Steady" acceptable range of weighing part. If there is vibration on weighing part, you can set this function and reduce the vibration effect on weighing process. 0 : Weak vibration ┆ 9 : Strong Vibration	
Zero Tracking Compensation Range setting				
F04	5	0 ┆ 9	Due to external causes(Temperature, wind, and dust), there are small weight difference, indicator will ignore the weight difference and display Zero. For this compensation function, indicator will estimate the weight difference is over the set range during fixed time period. If there is large weight difference over set range within fixed time period, the "Zero" is breaking and will find new zero point.	
Auto Zero Range setting				
F05	00	00 ┆ 99	Within the "Auto Zero" range, weighing part is steady, indicator will display current weight as "Zero" If the weighing part is not "Steady", indicator will display current weight. (Auto Zero Range : ± Set value + weight unit)	
Digital Filter setting				
F06	15	00 ┆ 49	Small set value for weak vibration Large set value for strong vibration	Small set value more sensitive
Zero /Tare key Operation mode selection				
F07	●	0	Activate when "Steady" condition, only	
		1	Always activated	

Zero key Operation Range selection						
F08		0	Activated within 2% of Max. Capacity			
		1	Activated within 5% of Max. Capacity			
		2	Activated within 10% of Max. Capacity			
	●	3	Activated within 20% of Max. Capacity			
		4	Activated within 100% of Max. Capacity			
Tare key Operation Range selection						
F09		0	Activated within 10% of Max. Capacity			
		1	Activated within 20% of Max. Capacity			
		2	Activated within 50% of Max. Capacity			
	●	3	Activated within 100% of Max. Capacity			
"Hold" Mode selection						
F10	●	0	Peak Hold : Measure Max. weight value and hold on display.			
		1	Sample Hold : Hold current weight until "Hold Reset".			
		2	Average Hold : Make average during 3sec, and hold display			
		3	Average Hold : Make average during 5sec, and hold display			
		4	Average Hold : Make average during 8sec, and hold display			
External Input Selection						
F11	Set Value		Input 1	Input 2	Input 3	Input 4
	●	0	Zero	Tare	Tare Reset	Print
		1	Zero	Tare/Reset	Hold	Hold Reset
		2	Zero	Tare/Reset	Sub Total	Print
		3	Zero	Hold	Hold Reset	Print
		4	Zero	Sub Total	Grand Total	Print
		5	Zero	Tare	Tare Reset	Net/Gross
		6	Zero	Print	Sub Total	Sub Total Delete
	7	Zero	Print	Grand Total	Grand Total Delete	
Code No. setting						
F12	●	0	Fixed Code No.			
		1	Increase Code No., whenever finish one weighing process			
		2	Decrease Code No., whenever finish one weighing process			

Serial No. Key setting			
F13	<input checked="" type="radio"/>	0	S/N key Activate – Use S/N key function
	<input type="radio"/>	1	S/N key Deactivate – Not use S/N key function
Hold “Off” time setting			
F14	00	00 ┆ 99	Time setting of the “Hold Off” After set time, Hold function will be off automatically.

Communication setting

Parity Bit selection Mode – Port 1(Standard)			
F30	<input checked="" type="radio"/>	0	No Parity
	<input type="radio"/>	1	Odd Parity
	<input type="radio"/>	2	Even Parity
Serial Communication Speed selection– Port 1(Standard)			
F31	<input type="radio"/>	0	115,200bps
	<input type="radio"/>	1	76,800bps
	<input type="radio"/>	2	57,600bps
	<input type="radio"/>	3	38,400bps
	<input type="radio"/>	4	28,800bps
	<input type="radio"/>	5	19,200bps
	<input type="radio"/>	6	14,400bps
	<input checked="" type="radio"/>	7	9,600bps
	<input type="radio"/>	8	4,800bps
	<input type="radio"/>	9	2,400bps
Serial I/F Mode setting (Under F33-00 setting, only) – Port 1(Standard)			
F32	<input checked="" type="radio"/>	0	Steam Mode : Continuous Data transfer
	<input type="radio"/>	1	Steady Mode : Single time data transfer, when the weight is steady
	<input type="radio"/>	2	Print Mode : Single time data transfer, when print key input

Serial I/F Transference method setting– Port 1(Standard)			
F33	<input checked="" type="radio"/>	0	Simplex Mode
	<input type="radio"/>	1	Duplex Mode / Command Mode
	<input type="radio"/>	2	LCD Mode
	<input type="radio"/>	3	Not Use
	<input type="radio"/>	4	External Display Mode
	<input type="radio"/>	5	Not Use
ID No. setting			
F34	01	01 ┆ 99	ID No. setting with No. key. (01 ~99 settable)
Transferred Data Format– Port 1(Standard)			
F35	<input checked="" type="radio"/>	0	Format 1.
	<input type="radio"/>	1	Format 2. (Format 1 + time)
	<input type="radio"/>	2	Format 3.
BCC Selection Mode			
F36	<input checked="" type="radio"/>	0	BCC not use
	<input type="radio"/>	1	BCC Use
Data Transference count setting – Port 1(Standard)			
F37	<input type="radio"/>	0	About 40times/sec
	<input type="radio"/>	1	About 30times/sec
	<input type="radio"/>	2	About 20times/sec
	<input checked="" type="radio"/>	3	About 15times/sec
	<input type="radio"/>	4	About 10times/sec
	<input type="radio"/>	5	About 5times/sec
	<input type="radio"/>	6	About 3times/sec
Parity Bit selection Mode – Port 2(OPTION)			
F40	<input checked="" type="radio"/>	0	No Parity
	<input type="radio"/>	1	Odd Parity
	<input type="radio"/>	2	Even Parity

Serial Communication Speed selection – Port 2(Optional)			
F41		0	115,200bps
		1	76,800bps
		2	57,600bps
		3	38,400bps
		4	28,800bps
		5	19,200bps
		6	14,400bps
	●	7	9,600bps
		8	4,800bps
		9	2,400bps
Serial I/F Mode setting (Under F43-00 setting, only) – Port 2(Optional)			
F42	●	0	Stream Mode : Continuous Data transfer
		1	Steady Mode : Single time data transfer, when the weight is steady
		2	Print Mode : Single time data transfer, when print key input
Serial I/F Transference method setting – Port 2(Optional)			
F43	●	0	Simplex Mode
		1	Duplex Mode / Command Mode
		2	Not Use
		3	LCD Mode
		4	Not Use
		5	Not Use
Transferred Data Format– Port 2(Optional)			
F45	●	0	Format 1.
		1	Format 2. (Format 1 + time)
		2	Format 3.
Data Transference count setting – Port 2(Optional)			
F47		0	About 40times/sec
		1	About 30times/sec
		2	About 20times/sec

	<input checked="" type="radio"/>	3	About 15times/sec
	<input type="radio"/>	4	About 10times/sec
	<input type="radio"/>	5	About 5times/sec
	<input type="radio"/>	6	About 3times/sec

Serial Printer Setting

Weight Unit selection (Printer)			
F50	<input checked="" type="radio"/>	0	kg
	<input type="radio"/>	1	g
	<input type="radio"/>	2	t
When Automatically print, Data output selection			
F51	<input checked="" type="radio"/>	0	When weight reached Empty Range(F80 set value), Automatically print. - Check Empty Range
	<input type="radio"/>	1	Over than Empty Range, Steady Lamp is "ON", Automatically Print. - Will not check Empty Range
Print Format selection			
F52	<input checked="" type="radio"/>	0	Continuous Print Serial No. and Weight will be printed continuously.
	<input type="radio"/>	1	Single Print Date, Time, S/N, ID No. Weighing Data will be print
SUB/GRAND Total Data Delete selection			
F53	<input checked="" type="radio"/>	0	Manual Delete Mode SUN Total Delete : "Clear" key + "SUB" key GRAND Total Delete : "Clear" key + "GRAND" key
	<input type="radio"/>	1	Automatic Delete Mode After SUB/GRAND Total Print, Automatically Deleted.
Paper Withdraw Rate setting (After Finish Printing process)			
F54	4	0 ┆ 9	Whenever set value increased, 1line will be added.

Printer Line Interval Selection (Only for Continuous Printer format)			
F55	1	0 ┆ 9	Whenever set value increased, 1line will be added.
SUB Total Print Mode Selection			
F56	<input checked="" type="radio"/>	0	Normal Mode
	<input type="radio"/>	1	Normal Mode + Average total value print
Printing Language Selection			
F57	<input checked="" type="radio"/>	0	KOREAN
	<input type="radio"/>	1	ENGLISH
Print Delay time Setting			
F58	00	00 ┆ 99	00 : No Delay time 0.1~9.9 : 9.9sec later, print output

BCD output Selection			
F60	<input checked="" type="radio"/>	0	Positive output
	<input type="radio"/>	1	Negative output
Average Display setting			
F63	00	00 ┆ 99	00 setting : Average Display mode not use 01~99 setting : make average every 99pcs display data and display
Steady LED Status Lamp Delay time setting			
F64	00	00 ┆ 99	00 setting : No delay for the Steady LED lamp 0.1~9.9 setting : Delay during 9.9sec, and LED lamp will be ON.
Tension and Compression setting			
F65	<input checked="" type="radio"/>	0	Not Use (JP1 switch OFF at main board)
	<input type="radio"/>	1	Use (JP1 switch ON at main board and then must be re-calibration)

Other Setting

EMPTY Range setting		
F80	X.X.X.X.X.X. (0.0.0.0.1.0)	<p>You can set "EMPTY" Range. Within set range, indicator will not display current weight and just display "Zero".</p> <p>"0.000" setting : When Net Zero, "Zero" status lamp and Near Zero relay will be output.</p> <p>"0.190" setting : Within 190, "Zero" Status lamp and Near Zero relay will be output.</p>
Zero Range setting		
F81	XXXXXX	<p>Within this "Zero Range setting", all the weight value will be displayed, As "0"</p>
Analogue Output Setting (only for the analogue option installation)		
F83	XXXXXX	<p>At the set weight value, analogue output will be maximized. Ex.) Set 5000, then a weight reached 5000 → 20mA or 10V will be output But if you need just 3000 of Max. capa, you can input 3000 through this function, then the weight reached 3000 → 20mA or 10V will be output</p>
Span Value Check		
F89	XXXXXX	<p>At this function, you can check the Calculated Span value.</p> <p>※ If you have difficulty to process Calibration again, the best way to matching the net weight and display weight is doing Calibration process once again.</p>
DATE Check / Change		
F90	Check Current DATE data or you can Change to new date	
TIME Check / Change		
F91	Check Current TIME data or you can Change to new TIME	

Chapter 6. Interface

1. Rs-232C (Standard Installed)

RS-232C Serial Interface is sensitive/weak for electric Noise.

So, please isolate with AC power cable and use shield cable to reduce the electric noise effect.

1-1. Connection



DN500N-Series Indicator

RXD2 ----- Pin3 TXD

TXD2 ----- Pin2 RXD

GND2----- Pin5 GND



PC(D-Sub 9Pin)



DN500N-Series Indicator

TXD2 ----- RXD

GND2 ----- GND



Remote Display

1-2. Signal Format

- ①. Type : EIA-RS-232C
- ②. Communication Method : Half-Duplex, Full Duplex, Asynchronous
- ③. Serial Baud Rate : Selectable
- ④. Data Bit : 8(No Parity mode, only)Bit.
- ⑤. Stop Bit : 1
- ⑥. Parity Bit : Non, Even, Odd (Selectable)
- ⑦ Code : ASCII

1-3. Data Protocol (Data Format 1. – Total 18byte)



▶ Header 1

- OL : OVER LOAD or UNDER LOAD
- ST : Weight Stable
- US : Weight Unstable

▶ Header 2

- NT : Net Weight (Without TARE Weight)
- GS : Gross Weight (With TARE Weight)

▶ DATA(8) Symbol(1) , Decimal Point(1) , Weight (6) = total 8BYTE, like +000.190

- 2B(H): "+"PLUS
- 2D(H): "-"MINUS
- 2O(H): " "SPACE
- 2E(H): "."Decimal point

▶ UNIT

- Kg , g

2. Current Loop Interface (Standard installed)

“Current Loop” Interface is stronger for Electric Noise than “RS-232C” interface.
So, it can be used for long distance communication.(About 100m long distance).



2-1. Connection

C/L ----- RXD

C/L ----- GND



DN500N Series Indicator

Remote Display

2-2. Current Loop Circuit Diagram.

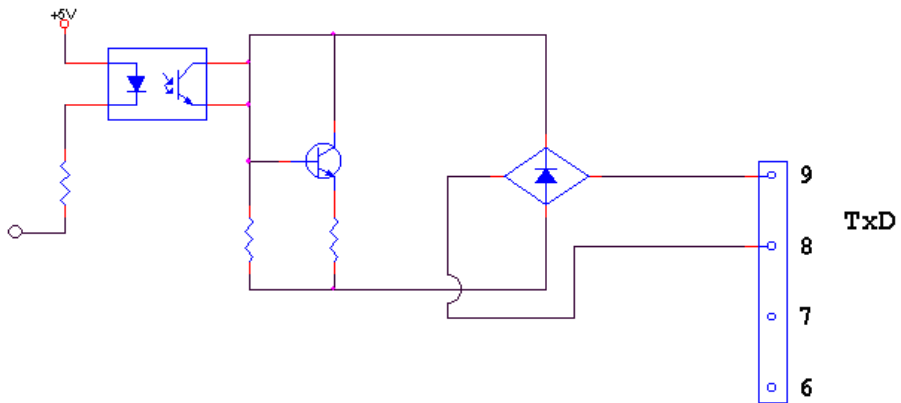

3. Rs-422 Serial Interface (Option)

RS-422/485 serial interface is more stable for electric noise effect compare with other communication method, using electric current difference.

But, install isolated place from Power cable or other electric cables and wires, and please use shielded cable for better performance.

Recommendable communication distance is about 1.2km.

3-1. Connection



DN510N-Series Indicator

Pin6 RXD+ ----- TXD+
 Pin7 RXD- ----- TXD-
 Pin8 TXD+ ----- RXD+
 Pin9 RXD- ----- RXD-



PC(D-Sub 9Pin)

3-2. Signal Format (As Same as "Rs-232C Serial interface)





























- ①. Type : EIA-RS-232C
- ②. Communication Method : Half-Duplex, Full Duplex, Asynchronous
- ③. Serial Baud Rate : Selectable
- ④. Data Bit : 8(No Parity mode, only)Bit.
- ⑤. Stop Bit : 1
- ⑥. Parity Bit : Non, Even, Odd (Selectable)
- ⑦ Code : ASCII

3-3. Data Protocol (Data Format 1. – Total 18byte) - As same as "Rs-232c Serial Interface



► COMMAND MODE

1. READ COMMAND [Start(STX ) , End(ETX ) , Succeed(ACK ) , Failed(NAK )]

RxD & TxD	Transfer & Response display	Command
PC→Indicator Format	 01RDAT  (ASCII) 02 30 31 52 44 41 54 03 (HEX)	Date Data
Response from Indicator	 01RDAT100619  (ASCII) 02 30 31 52 44 41 54 31 30 30 36 31 39 06 03 (HEX)	
PC→Indicator Format	 01RTIM  (ASCII) 02 30 31 52 54 49 4D 03 (HEX)	Time Data
Response from Indicator	 01RTIM122146  (ASCII) 02 30 31 52 54 49 4D 31 32 32 31 34 36 06 03 (HEX)	
PC→Indicator Format	 01RSNO  (ASCII) 02 30 31 52 53 4E 4F 03 (HEX)	Serial No.
Response from Indicator	 01RSNO000000  (ASCII) 02 30 31 52 53 4E 4F 30 30 30 30 30 30 06 03 (HEX)	
PC→Indicator Format	 01RCNO  (ASCII) 02 30 31 52 43 4E 4F 03 (HEX)	Code No.
Response from Indicator	 01RCNO000058  (ASCII) 02 30 31 52 43 4E 4F 30 30 30 30 35 38 06 03 (HEX)	
PC→Indicator Format	 01RPNO  (ASCII) 02 30 31 52 50 4E 4F 03 (HEX)	Part No.
Response from Indicator	 01RPNO19  (ASCII) 02 30 31 52 50 4E 4F 31 39 06 03 (HEX)	
PC→Indicator Format	 01RTAR  (ASCII) 02 30 31 52 54 41 52 03 (HEX)	TARE weight value
Response from Indicator	 01RTAR000758  (ASCII) 02 30 31 52 54 41 52 30 30 30 37 35 38 06 03 (HEX)	
PC→Indicator Format	 01RCWT  (ASCII) 02 30 31 52 43 57 54 03 (HEX)	Current Weight value
Response from Indicator	 01RCWTSTNT+00027.6kg  (ASCII) 02 30 31 52 43 57 54 53 54 4E 54 2B 30 30 30 32 37 2E 36 6B 67 06 03 (HEX)	

Remark	STX(1) ID(2) Command(4) Status1(2) Status2(2) Symbol(1) Weight (Include decimal point)(7) Unit(2) ACK(1) ETX(1) = Total 23 BYTE	
PC→Indicator Format	Ⓜ01RSUB♥ (ASCII) 02 30 31 52 53 55 42 03 (HEX)	Sub-Total Data
Response from Indicator	Ⓜ01RSUB01000001000003000004473♥ (ASCII) 02 30 31 52 53 55 42 30 31 30 30 30 30 31 (HEX) 30 30 30 30 30 33 30 30 30 30 34 34 37 33 06 03	
Remark	STX(1) ID(2) Command(4) P/N(2) Code(6) Sub-Total times(6) Sub-Total Weight(8) ACK(1) ETX(1) = Total 31 BYTE	
PC→Indicator Format	Ⓜ01RGRD♥ (ASCII) 02 30 31 52 53 55 42 03 (HEX)	Grand-Total Data
Response from Indicator	Ⓜ01RGRD0100000100000300000004473♥ (ASCII) 02 30 31 52 53 55 42 30 31 30 30 30 30 31 30 30 30 30 30 33 30 30 30 30 30 30 34 34 37 33 06 03 (HEX)	
Remark	STX(1) ID(2) Command(4) P/N(2) Code(6) Grand-Total times(6) Grand-Total Weight(10) ACK(1) ETX(1) = Total 33 BYTE	
PC→Indicator Format	Ⓜ01RFIN♥ (ASCII) 02 30 31 52 46 49 4E 03 (HEX)	Weighing Condition
Response from Indicator	Ⓜ01RFIN001568♥ (ASCII) 02 30 31 52 46 49 4E 30 30 31 35 36 38 06 03 (HEX)	
PC→Indicator or Format	Ⓜ01RCWD♥ (ASCII) 02 30 31 52 46 49 4E 03 (HEX)	Memorized Data
Response from Indicator	Ⓜ01RCWD10062010200001000001000004000138000276000414♥ 02 30 31 52 43 57 44 31 30 30 36 32 30 31 30 32 30 30 30 30 31 30 30 30 30 31 30 30 30 30 30 34 30 30 30 31 33 38 30 30 30 32 37 36 30 30 30 34 31 34 06 03 (HEX)	
Remark	STX(1) ID(2) Command(4) Date(6) Time(6) P/N(2) Code(6) Sub-Total times(6) Tare(6) Current Weight(6) Grand-Total Weight(6) ACK(1) ETX(1) = Total 53 BYTE	

2. WRITE COMMAND [Start(STX ) , End(ETX ) , Succeed(ACK ) , Failed(NAK )]

RxD & TxD	Transfer & Response display	Command
PC→Indicator Format	01WTAR (ASCII) 02 30 31 57 54 41 52 03 (HEX)	TARE input
Response from Indicator	01WTAR (ASCII) 02 30 31 57 54 41 52 06 03 (HEX)	
PC→Indicator Format	01WTRS (ASCII) 02 30 31 57 54 52 53 03 (HEX)	TARE RESET
Response from Indicator	01WTRS (ASCII) 02 30 31 57 54 52 53 06 03 (HEX)	
PC→Indicator Format	01WZER (ASCII) 02 30 31 57 5A 45 52 03 (HEX)	ZERO input
Response from Indicator	01WZER (ASCII) 02 30 31 57 5A 45 52 06 03 (HEX)	
PC→Indicator Format	01WPRT (ASCII) 02 30 31 57 50 52 54 03 (HEX)	Print input
Response from Indicator	01WPRT (ASCII) 02 30 31 57 50 52 54 06 03 (HEX)	
PC→Indicator Format	01WSPR (ASCII) 02 30 31 57 50 52 54 03 (HEX)	Sub-Total Print
Response from Indicator	01WSPR (ASCII) 02 30 31 57 53 50 52 06 03 (HEX)	
PC→Indicator Format	01WGPR (ASCII) 02 30 31 57 47 50 52 03 (HEX)	Grand-Total Print
Response from Indicator	01WGPR (ASCII) 02 30 31 57 47 50 52 06 03 (HEX)	
PC→Indicator Format	01WDAT100619 (ASCII) 02 30 31 57 44 41 54 31 30 30 36 31 39 03 (HEX)	Date setting
Remark	STX(1) ID(2) Command(4) Date(6) ETX(1)	
Response from Indicator	01WDAT (ASCII) 02 30 31 57 44 41 54 06 03 (HEX)	

PC→Indicator Format	01WTIM122146 (ASCII) 02 30 31 57 54 49 4D 31 32 32 31 34 36 03 (HEX)	Time setting
Remark	STX(1) ID(2) Command (4) Time(6) ETX(1)	
Response from Indicator	01WTIM (ASCII) 02 30 31 57 54 49 4D 06 03 (HEX)	
PC→Indicator Format	01WSND0000058 (ASCII) 02 30 31 57 43 4E 4F 30 30 30 30 35 38 03 (HEX)	Serial No. Change
Remark	STX(1) ID(2) Command (4) S/N(6) ETX(1)	
Response from Indicator	01WSND (ASCII) 02 30 31 57 53 4E 4F 06 03 (HEX)	
PC→Indicator Format	01WPND19 (ASCII) 02 30 31 57 50 4E 4F 31 39 03 (HEX)	Part No. Change
Remark	STX(1) ID(2) Command (4) P/N (2) ETX(1)	
Response from Indicator	01WPND (ASCII) 02 30 31 57 50 4E 4F 06 03 (HEX)	
PC→Indicator Format	01WCND0000058 (ASCII) 02 30 31 57 43 4E 4F 30 30 30 30 35 38 03 (HEX)	Code No. Change
Remark	STX(1) ID(2) Command (4) Code(6) ETX(1)	
Response from Indicator	01WCND (ASCII) 02 30 31 57 43 4E 4F 06 03 (HEX)	
PC→Indicator Format	01WHOL (ASCII) 02 30 31 57 48 4F 4C 03 (HEX)	Hold input
Response from Indicator	01WHOL (ASCII) 02 30 31 57 48 4F 4C 06 03 (HEX)	

PC→Indicator Format	001WHRS (ASCII) 02 30 31 57 48 52 53 03 (HEX)	Hold RESET
Response from Indicator	001WHRS (ASCII) 02 30 31 57 48 52 53 06 03 (HEX)	
PC→Indicator Format	001WSTC (ASCII) 02 30 31 57 53 54 43 03 (HEX)	Sub-Total Data Clear
Response from Indicator	001WSTC (ASCII) 02 30 31 57 53 54 43 06 03 (HEX)	
PC→Indicator Format	001WGTC (ASCII) 02 30 31 57 47 54 43 03 (HEX)	Grand-Total Data Clear
Response from Indicator	001WGTC (ASCII) 02 30 31 57 47 54 43 06 03 (HEX)	
PC→Indicator Format	001WAUT (ASCII) 02 30 31 57 4D 55 4C 03 (HEX)	“Auto key” input
Response from Indicator	001WAUT (ASCII) 02 30 31 57 4D 55 4C 06 03 (HEX)	
PC→Indicator Format	001WMUL (ASCII) 02 30 31 57 41 55 54 03 (HEX)	“Manual key” input
Response from Indicator	001WMUL (ASCII) 02 30 31 57 41 55 54 06 03 (HEX)	

4. Analogue Output (0~10V / Option)

This Option card converts weight value to Analog Voltage output(0~10V) and transfers to external devices(Recorder, P.L.C), controlled by voltage output.

4-1. Specification

- Output Voltage : 0~10V DC output
- Accuracy : More than 1/1,000

※ **As we convert Digital signal(1/30,000 accuracy) to Analogue, so the accuracy will be lower than Digital signal**

4-2. Circuit Diagram and Pint Connection

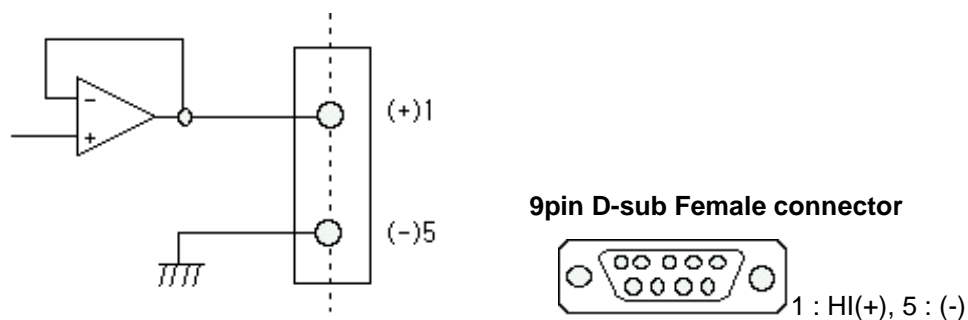

※ This Voltage output is proportioned on weight calibration and outputs 0~10V.

4-3. Adjustment

This output is adjusted as when the weight is “Zero”, output is 0V and When the weight is “Full capacity”, output is 10V.

If you need additional adjustment, please adjust with “VR1(Zero)”, “VR2(Span)” on the Analog Output PCB.

※ Remark

This Analog option card converts Displayed weight value(Micro-process data) to analog value on D/A Converter(Digital to Analog converter)

This D/A Converter has Max. 1/4,000 accuracy, so this output is not suitable for high accuracy application, like more than 1/3,000.

For 0~5VDC or 1~5VDC analog output, please inform when you inquiry.

4-4. Output Test

Enter to “TEST” mode and select TEST mode 2(key test).

If you press No.1(0V) / No.2(2.5V) / No.3(5V) / No.4(7.5V) / No.5(10V) will be output.

5. Analogue Output (4~20mA / Option)

This Option card converts weight value to Analog Voltage output(4~20mA) and transfers to external devices(Recorder, P.L.C), controlled by voltage output.

5-1. Specification

- Output Voltage : 4~20mA output (Max.2~22mA)
- Accuracy : More than 1/1,000
- Temperature Coefficient : 0.01%/°C
- Max. Loading Impedance : Max. 500Ω

※ As we convert Digital signal(1/30,000 accuracy) to Analogue, so the accuracy will be lower than Digital signal

5-2. Circuit Diagram and Pint Connection

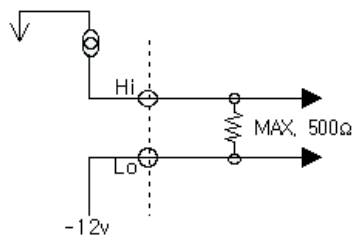

9pin D-sub Female connector

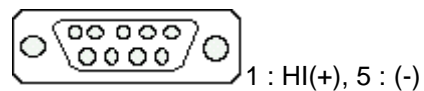

※ “LO” terminal is not a “GND”, so this “LO” terminal do not be connected with other “GND” terminal on other devices.

※ This output is proportioned on weight calibration and outputs 4~20mA.

5-3. Output Adjustment

①. This output is adjusted as when the weight is “Zero”, output is “4mA” and When the weight is “Full capacity”, output is “20mA”.

②. If you need additional adjustment, please adjust with “VR1(Zero)”, “VR2(Span)” on the Analog Output PCB.

※ Remark

This Analog option card converts Displayed weight value(Micro-process data) to analog value on D/A Converter(Digital to Analog converter)

This D/A Converter has Max. 1/4,000 accuracy, so this output is not suitable for high accuracy application, like more than 1/3,000.

6. BCD Input (Option)

This “BCD interface” option card can be applied on PLC (Programmable Logic Controller), or Score Board applications.

Each Input circuit is isolated with “Photo-Coupler”, from external devices electrically.

6-1. Circuit Diagram

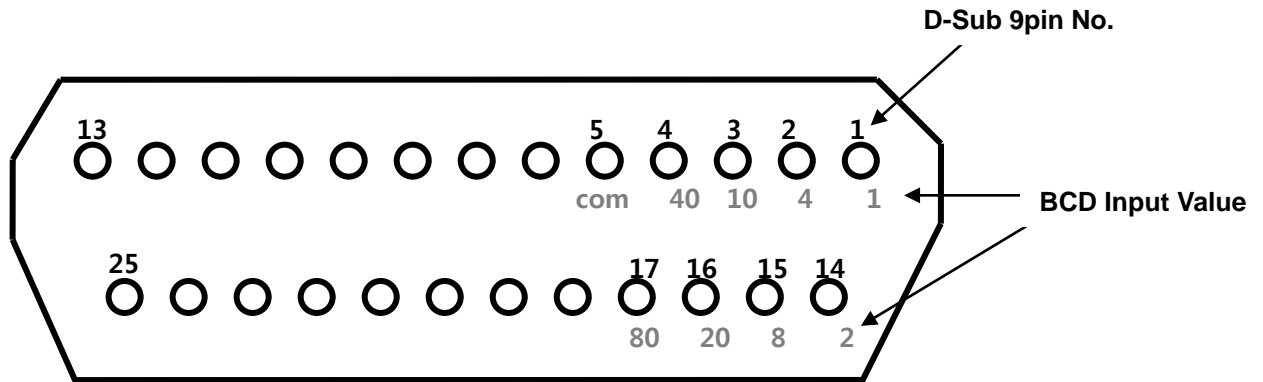

This Option card can be used for changing Part No. setting from external devices.

7. BCD Output (Option)

This “BCD interface” option card can be applied on PLC (Programmable Logic Controller), or Score Board applications.

Each Input circuit is isolated with “Photo-Coupler”, from external devices electrically.

PIN NO.	SIGNAL	PIN NO.	SIGNAL
1	GROUND(GND)	26	HI : NET, LOW : Gross
2	1×10^0	27	NC
3	2×10^0	28	NC
4	4×10^0	29	NC
5	8×10^0	30	NC
6	1×10^1	31	EX INPUT3 (Part Number)
7	2×10^1	32	EX INPUT2 (Part Number)
8	4×10^1	33	NC
9	8×10^1	34	NC
10	1×10^2	35	NC
11	2×10^2	36	NC
12	4×10^2	37	NC
13	8×10^2	38	NC
14	1×10^3	39	NC
15	2×10^3	40	NC
16	4×10^3	41	NC
17	8×10^3	42	Hi : Positive Polarity (+)
18	1×10^4	43	HI : Decimal Point 10^1
19	2×10^4	44	HI : Decimal Point 10^2
20	4×10^4	45	HI : Decimal Point 10^3
21	8×10^4	46	HI : OVER LOAD
22	1×10^5	47	Positive, Negative output (F-50)
23	2×10^5	48	EX INPUT1 (Part Number)
24	4×10^5	49	BUSY
25	8×10^5	50	EX INPUT0 (Part Number)

* F60 , 0→ Positive output, 1→ Negative output

***** Please donot connect + Polarity at No.1PIN1. Only connect GND Polarity**

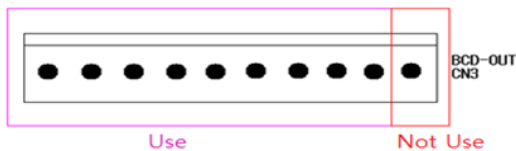

The 9 Pin connector is connected at CN3 of main board.

8. Serial Printer Interface (Standard).

This interface can be connected all kinds of serial interface installed printer devices.

But, programmed print format is specialized with our serial printer only.

So, if you use different model, the format can be changed or not printed.

8-1. Printer Specification

1. Interface : Rs-232
2. Protocol : 9600 bps, No Parity, Data(8), Stop(1)
3. Column : 30 Column
4. Printing type : Combination type

8-2. Pin Connection



DN500N Series Indicator



Serial Printer

8-3. Print Port

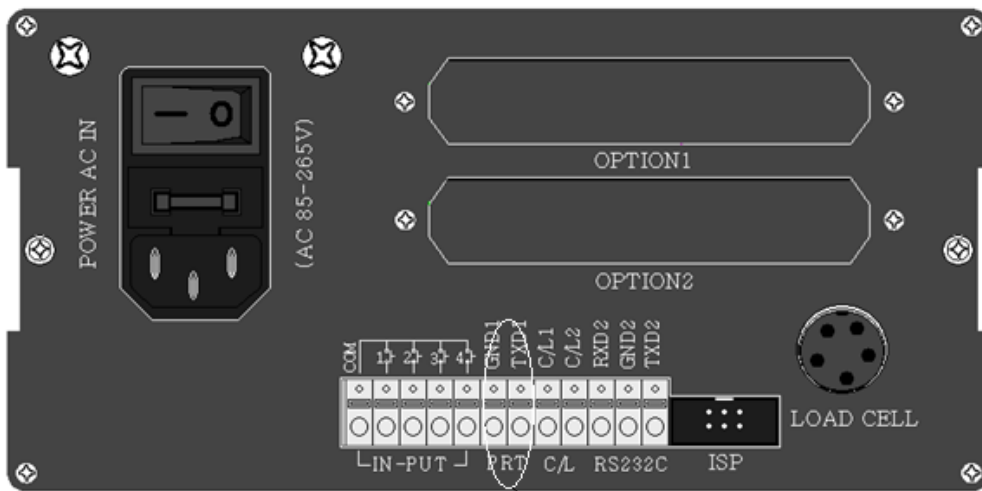

Print port (PRT)

9. Serial Print Format

Single Print Format

```

=====
DATE : 2006/12/14 THU
TIME : 15:26:32
PART CODE SERIAL WEIGHT
1 1 1 50.00 kg
=====
DATE : 2006/12/14 THU
TIME : 15:26:38
PART CODE SERIAL WEIGHT
1 1 2 50.00 kg
=====
DATE : 2006/12/14 THU
TIME : 15:26:43
PART CODE SERIAL WEIGHT
1 1 3 2.24 kg
=====
DATE : 2006/12/14 THU
TIME : 15:26:50
PART CODE SERIAL WEIGHT
1 1 4 3.02 kg
=====

```

Continuous Print Format

```

=====
DATE : 2006/12/14 THU
TIME : 15:28:55
PART CODE SERIAL WEIGHT
1 1 1 50.00 kg
1 1 2 50.00 kg
1 1 3 50.01 kg
1 1 4 50.00 kg
1 1 5 20.62 kg
=====

```

Sub-Total Print Format

```

=====
SUB-TOTAL
DATE : 2006/12/14 THU
TIME : 15:29:30
PART : 1
CODE : 1
MIN : 20.62 kg
MAX : 50.01 kg
AVG : 44.12 kg
T-COUNT : 5
T-WEIGHT : 220.63 kg
=====

```

Grand Total Print Format

```

=====
GRD-TOTAL
DATE : 2006/12/14 THU
TIME : 15:29:31
PART CODE SERIAL WEIGHT
1 1 5 220.63 kg

T-PART : 1
T-COUNT : 5
T-WEIGHT : 220.63 kg
=====

```

Chapter 7. Error and Treatment

1. TEST Mode

TEST Mode No.	Contents	Detail information
TEST 1.	Analogue TEST mode	This mode is Analogue testing
TEST 2.	Keypad TEST mode	This mode is Keypad testing or Analogue Option Card Test (4~20mA or 0~10v) - No.1 key : 4mA / 0V output - No.2 key : 8mA / 2.5V output - No.3 key : 12mA / 5V output - No.4 key : 16mA / 7.5V output - No.5 key : 20mA / 10V output
TEST 3.	SET.CAL Mode	This mode is F-Function setting or Calibration setting
TEST 4.	Display TEST Mode	Check that display is normal or not
TEST 5.	Relay output TEST Mode	If have a relay, check the relay output
TEST 6.	External input(Digital Input)TEST Mode	Check that external input is normal or not
TEST 7.	Un-Calibrated Analogue TEST Mode	Check the pure analogue value when not calibration

※ If you installed Analogue Option card, you can test Analogue output test with “TEST 2” mode. (Please check detailed information)

Enter to TEST Mode



Turn on the power with pressing  key.

Then, display will show , then press No. key and move to the certain TEST mode.

Exit from TEST Mode

Press  key to exit from each TEST mode.

Then, display will show .

※ Under TEST 3.  mode, press  key to exit .

2. Error and Treatment

2-1. Load Cell Installation

Error	Cause	Treatment	Remark
Weight Value is unstable	1). Load cell broken 2). Load cell isolation resistance error 3). Weighing part touches other devices or some weight is on the weighing part 4). Summing Board Error	1). Measure input/output resistance of Load cell. 2). Measure Load cell isolation resistance 3) Check attach point with other devices.	1).Input Resistance of "EX+" and "EX-" is about 350Ω~450Ω. 2). Output Resistance of "EX-" and "EX+" is about 350Ω. 3). Isolate Resistance is more than 100Ω
Weight Value is increased regular rate, but not return to "Zero"	1). Load cell Error 2). Load cell connection Error	1). Check Load cell connection 2). Measure Load cell Resistance	
Weight Value is increased to under Zero	Load cell Output wire (SIG+, SIG-) is switched	Make wire correction	
"UN PASS" display	Load cell broken or Indicator connection Error	Load cell Check Load cell connection Check	
	Power was "ON" when some weight is on the load cell?	Remove weight on the Load cell	
"OL" or "UL" display	1). Load cell broken or Indicator connection Error 2). Loading over than Max. Capacity	1). Load cell Check 2). Load cell connection Check 3). Remove over loaded weight	

2-2. Calibration Process

Error	Cause	Treatment
Err 01	When Max.capacity/digit value is over 20.00	Re-input the Max. Capacity, less than 20.00 (Max. Capacity / Digit)
Err 04	Standard weight value is over than Max. Capacity	Re-input Standard weight value with Number keys, under Max. Capacity
Err 05	Standard weight value is less than 10% of Max. Capacity	Re-input Standard weight value with Number keys, more than 10% of Max. Capacity
Err 06	1. Amp. Gain is too big 2. Sig+ and Sig- wire connection error 3. Test weight is not loaded	Check standard weight's weight with set value. If there is difference between set value and real weight, please re-input the value (set value is too small)
Err 07	1. Amp. Gain is too small 2. Sig+ and Sig- wire connection error 3. Test weight is not loaded	Check standard weight's weight with set value. If there is difference between set value and real weight, please re-input the value (set value is too big)
Err 08	Under "F-function" model, set value is "N.A"	Check the correct value and re-input
Err 09	When Y.Y has the value between 3.9 ~ 9.9 at Y.YXXXX as Span value, If standard weight value is less than 10% of Max. Capacity	Change the Max.capacity/digit value (Ex: digit 01 → 05)
Err A	When there is continuous vibration on the weighing part,, indicator can not process calibration any more.	- Find vibration cause and remove - Load cell check - Load cell cable and connecting condition check